

OETIKER

Accessories

Air Preparation Units

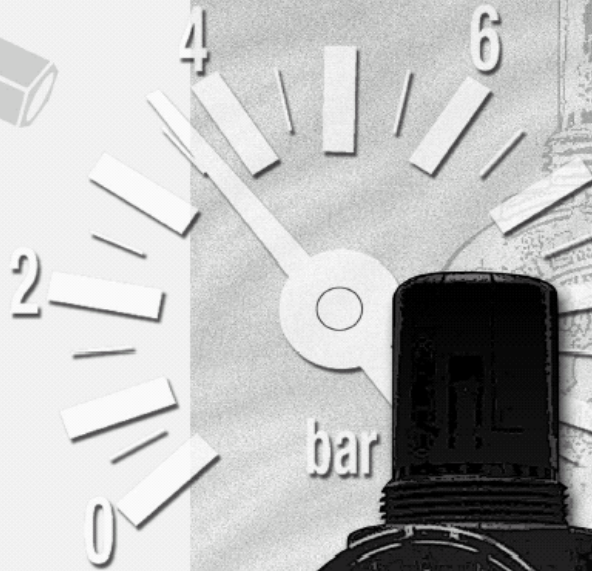
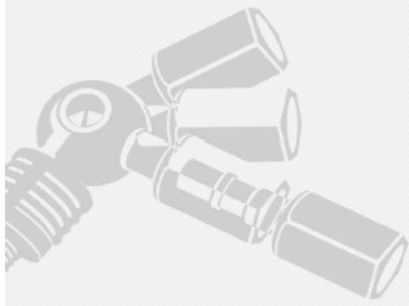

1 (800) 959-0398
www.oetiker.com
info@us.oetiker.com
Effective January 1, 2007
All prices are in US dollars.



Index of OETIKER Products

Air Preparation Units

Page 3 | Pressure Regulator

Page 3 | Filter-Regulator, 30µm

Page 3 | Filter-Regulator Combination with Oil Mist Lubricator

Page 4 | Oil Mist Lubricator

Page 4 | Filter-Water Separator

Air Preparation Units - Accessories

Page 5 | Replacement Bowl for Filter

Page 5 | Replacement Bowl for Oil Mist Lubricator

Page 5 | Replacement Filter Element (30µm and 5µm)

Page 5 | Gauge

Air Preparation Units - Dimensions of all Series

Page 6 | Air Preparation Units - Dimensions of all Series

Air Preparation Units - Flow Characteristics

Page 7 | Pressure Regulator Flow Characteristics

Page 7 | Filter-Regulator Flow Characteristics

Page 8 | Filter-Regulator Combination with Oil Mist Lubricator Flow Characteristics

Page 8 | Oil Mist Lubricator Flow Characteristics

Page 9 | Filter-Water Separator Flow Characteristics

OETIKER Terms and Conditions

Page 10 | Terms and Conditions



Oetiker, Inc.
3305 Wilson Street
Marlette, MI 48453
Tel: (989) 635-3621
info@us.oetiker.com
www.oetiker.com

OETIKER reserves the right to change specifications, dimensions, prices and discounts without notice.

Page 2
1-Jan-2007

OETIKER

Air Preparation Units



Pressure Regulator

All Pressure Regulators include mounting bracket and gauge

Part no.	Description	Connection	Flow [l/min]		Working pressure [bar]		USD List / Each
			recommend.	max.	Inlet max.	Outlet max.	
60200085	Regulation Valve Series 40	NPT 1/4"	550	770	10	8	\$34.00
60200083	Regulation Valve Series 50	NPT 3/8"	500	2850	16	8	\$55.00
60200081	Regulation Valve Series 60	NPT 1/2"	1900	5700	16	8	\$67.00

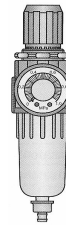

Filter-Regulator, 30µm

With manual condensate draining

All Filter-Regulators include mounting bracket and gauge

Part no.	Description	Connection	Flow [l/min]		Working pressure [bar]		USD List / Each
			recommend.	max.	Inlet max.	Outlet max.	
60200069	Filter-Regulator Series 40	NPT 1/4"	550	550	10	8	\$47.00
60200078	Filter-Regulator Series 50	NPT 3/8"	850	3200	16	8	\$77.00
60200073	Filter-Regulator Series 60	NPT 1/2"	1900	3300	16	8	\$102.00

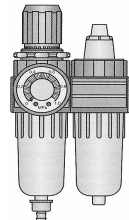

Filter-Regulator Combination with Oil Mist Lubricator

With manual condensate draining

All FRL Combinations include mounting bracket and gauge

Part no.	Description	Connection	Flow [l/min]		Working pressure [bar]		USD List / Each
			recommend.	max.	Inlet max.	Outlet max.	
60200060	FRL Combination Series 40	NPT 1/4"	550	580	10	8	\$100.00
60200048	FRL Combination Series 50	NPT 3/8"	680	790	16	8	\$156.00
60200061	FRL Combination Series 60	NPT 1/2"	1900	1950	16	8	\$189.00



Oetiker, Inc.
3305 Wilson Street
Marlette, MI 48453
Tel: (989) 635-3621
info@us.oetiker.com
www.oetiker.com

OETIKER reserves the right to change specifications, dimensions, prices and discounts without notice.

OETIKER

Air Preparation Units

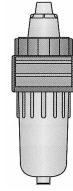

Oil Mist Lubricator

All Oil Mist Lubricators include mounting bracket

Part no.	Description	Connection	Flow [l/min]		Working pressure [bar]		USD List / Each
			recommend.	max.	min.	max.	
60200102	Oil Mist Lubricator Series 40	NPT 1/4"	550	1400	0	10	\$35.00
60200125	Oil Mist Lubricator Series 50	NPT 3/8"	850	1880	0	16	\$55.00
60200110	Oil Mist Lubricator Series 60	NPT 1/2"	1900	5300	0	16	\$99.00

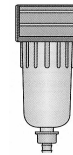

Filter-Water Separator

Filter (30µm) with manual condensate draining

All Filter-Water-Separator include mounting bracket

Part no.	Description	Connection	Flow [l/min]		Working pressure [bar]		USD List / Each
			recommend.	max.	min.	max.	
60200067	Filter-Water-Sep. Series 40	NPT 1/4"	550	1830	0	10	\$38.00
60200076	Filter-Water-Sep. Series 50	NPT 3/8"	850	1520	0	16	\$58.00
60200071	Filter-Water-Sep. Series 60	NPT 1/2"	850	4130	0	16	\$62.00



Oetiker, Inc.
3305 Wilson Street
Marlette, MI 48453
Tel: (989) 635-3621
info@us.oetiker.com
www.oetiker.com

OETIKER reserves the right to change specifications, dimensions, prices and discounts without notice.

OETIKER

Air Preparation Units

Accessories



Replacement Bowl for Filter

Part no.	Description	USD List / Each
60200020	Replacement Bowl for Filter Series 40	\$23.00
60200022	Replacement Bowl for Filter Series 50	\$46.00
60200024	Replacement Bowl for Filter Series 60	\$44.00



Replacement Bowl for Oil Mist Lubricator

Part no.	Description	USD List / Each
60200021	Replacement Bowl for Oil Mist Lubricator Series 40	\$9.00
60200023	Replacement Bowl for Oil Mist Lubricator Series 50	\$10.00
60200025	Replacement Bowl for Oil Mist Lubricator Series 60	\$31.00



Replacement Filter Element

Part no.	Description	USD List / Each
30µm		
60200026	Filter Element for Series 40, 30µm	\$4.00
60200027	Filter Element for Series 50, 30µm	\$7.00
60200028	Filter Element for Series 60, 30µm	\$18.00
5µm		
60200035	Filter Element for Series 40, 5µm	\$4.00
60200036	Filter Element for Series 50, 5µm	\$7.00
60200037	Filter Element for Series 60, 5µm	\$18.00



Gauge

Part no.	Description	USD List / Each
60200107	Gauge 0 - 145 PSI for Series 40 + 50, NPT 1/8"	\$11.00
60200030	Gauge 0 - 160 PSI for Series 60, NPT 1/4"	\$17.00



Oetiker, Inc.
 3305 Wilson Street
 Marlette, MI 48453
 Tel: (989) 635-3621
 info@us.oetiker.com
 www.oetiker.com

OETIKER reserves the right to change specifications, dimensions, prices and discounts without notice.

OETIKER

Air Preparation Units

Dimensions of all Series

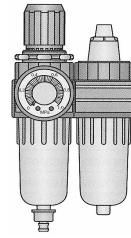

The present drawings include the dimensions of all elements related to a specific series.

Series 40

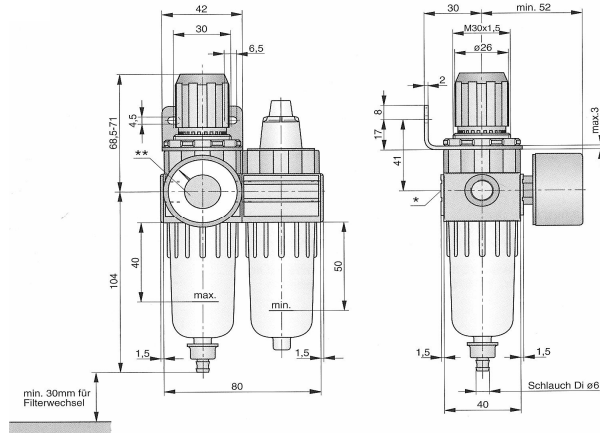

Series 50

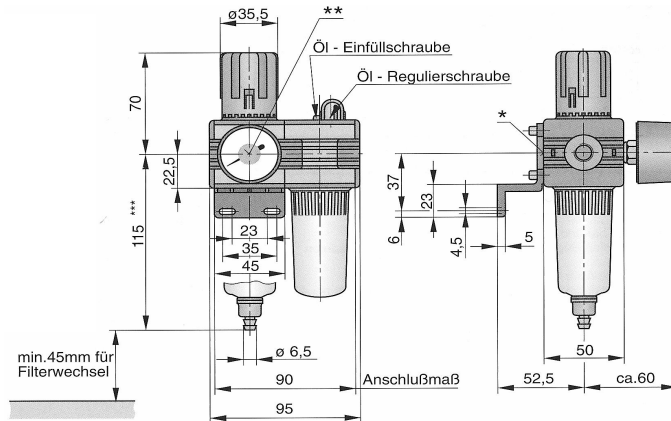

Series 60

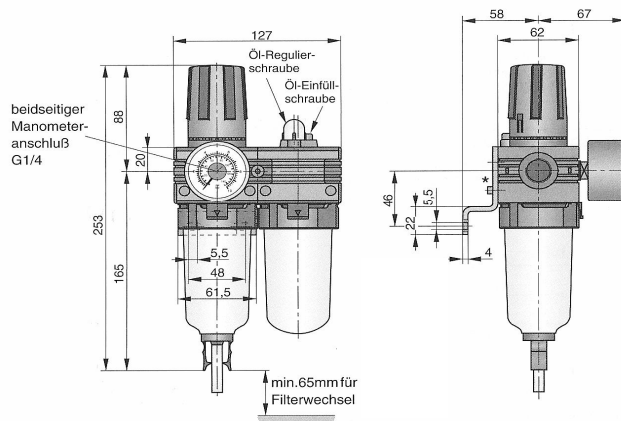

Oetiker, Inc.
 3305 Wilson Street
 Marlette, MI 48453
 Tel: (989) 635-3621
 info@us.oetiker.com
 www.oetiker.com

OETIKER

Air Preparation Units

Flow Characteristics

Pressure Regulator

Flow Characteristics

Series 40

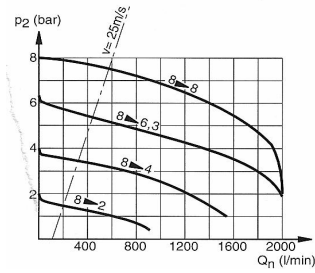

Series 50

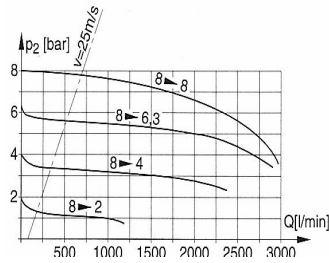

Series 60

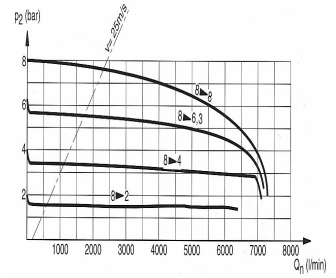

Filter-Regulator

Flow Characteristics

Series 40

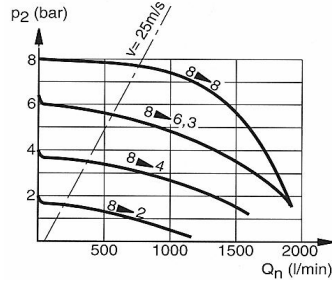

Series 50

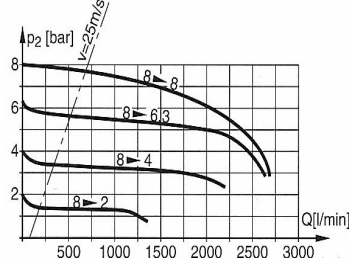

Series 60

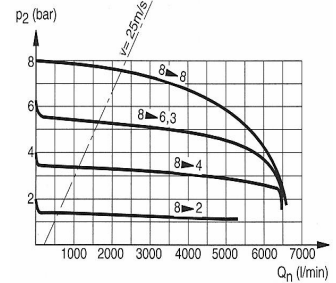

OETIKER

Air Preparation Units

Flow Characteristics

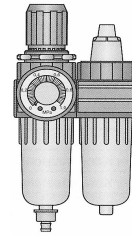

Filter-Regulator Combination with Oil Mist Lubricator

Flow Characteristics

Series 40

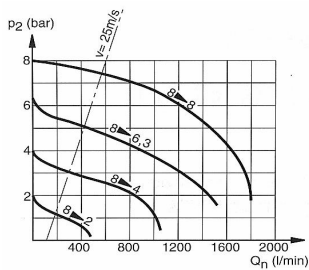

Series 50

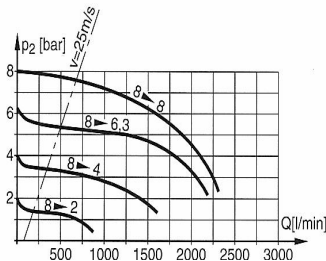

Series 60

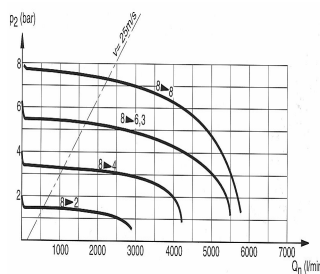

Oil Mist Lubricator

Flow Characteristics

Series 40

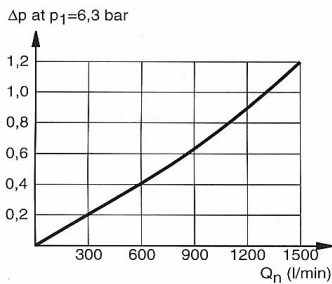

Series 50

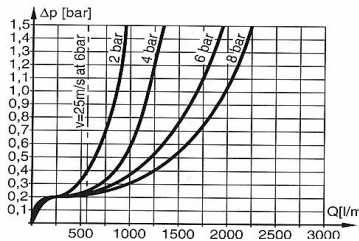

Series 60

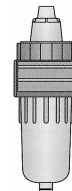
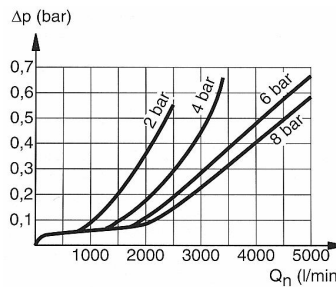

Oetiker, Inc.
 3305 Wilson Street
 Marlette, MI 48453
 Tel: (989) 635-3621
 info@us.oetiker.com
 www.oetiker.com

OETIKER

Air Preparation Units

Flow Characteristics

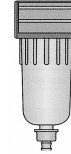

Filter-Water Separator Flow Characteristics

Series 40

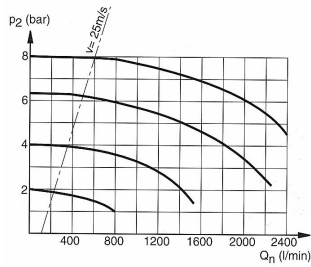

Series 50

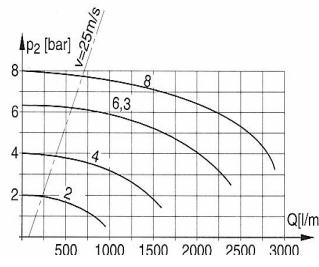

Series 60

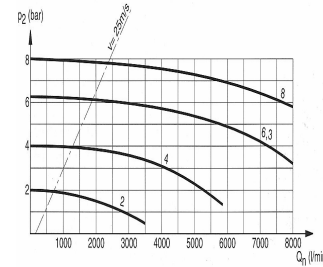

OETIKER

Terms and Conditions Warranty

FRL's Filters, Regulators, Lubricators

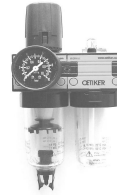

Return Policy:

Unused **NON-DEFECTIVE** items are subject to **15%** restocking charge and must be returned within six (6) months from invoice date. Custom made items are not returnable.

DEFECTIVE items may be returned at Oetiker's discretion for: credit, replacement, or repair. (Repair to be invoiced)

For a Return Authorization (RA) number before shipping product, please call Customer Service at 800-959-0398 in Michigan.

No returns of any type will be accepted without lot traceability and an RA number.

Returns must be received within 30 days of the issuance of the RA number.

All returns shall be in original sealed bags to ensure traceability.

Please have the following information on hand when calling for an RA number:

- Customer name
- Account number
- Original purchase order number
- Invoice number
- Nature of the problem

Credit will be issued within 30 days after returned product is received and if inspection and traceability requirements are met.

Limited Warranty:

Oetiker warrants its products to be free from defects in material and workmanship. Subject to limitations set forth herein, Oetiker further warrants that each product will substantially perform in accordance with the description of such product set forth in the relevant Oetiker sales material.

The exclusive remedy for: (i) defective materials or workmanship; (ii) or the failure of an Oetiker product to perform as described in the relevant sales materials, is limited to replacement or repair of the defective product if returned to Oetiker within six (6) months after the shipping date. However, the purchaser shall be entitled to no remedy if the alleged defect of an Oetiker product is caused in whole or in part by: (i) the failure of the purchaser to follow installation procedures provided by Oetiker and/or shown in Oetiker's catalogues; and/or (ii) the failure of the purchaser to use installation tools endorsed by Oetiker.

Except as expressly provided herein, Oetiker does not make any warranty or representation, express or implied, with respect to its products, including without limitation any implied or expressed warranty of merchantability or fitness for a particular purpose. In addition, under no circumstances shall Oetiker be liable for lost profits, lost savings or other consequential, incidental, special or indirect damages, or for acts of negligence that are not intentional or reckless in nature regardless of whether it has been advised of the possibility of such damages.

Payment Terms:

Orders can be shipped on a prepaid basis until credit has been established.

Taxes will be applied where applicable. **Minimum billing is \$200.00 (USD) per order.**

Shipments:

FOB Oetiker - Collect via carrier requested.

Additional charges apply for other than standard packaging.

Discrepancies in invoicing and delivery must be reported within 14 days after receiving.

Oetiker reserves the right to change specifications, dimensions, prices and discounts without notice.



Oetiker, Inc.
3305 Wilson Street
Marlette, MI 48453
Tel: (989) 635-3621
info@us.oetiker.com
www.oetiker.com

OETIKER reserves the right to change specifications, dimensions, prices and discounts without notice.

Page 10
01-Jan-07